

NYRIUS®

NPCS650

INSTRUCTION MANUAL

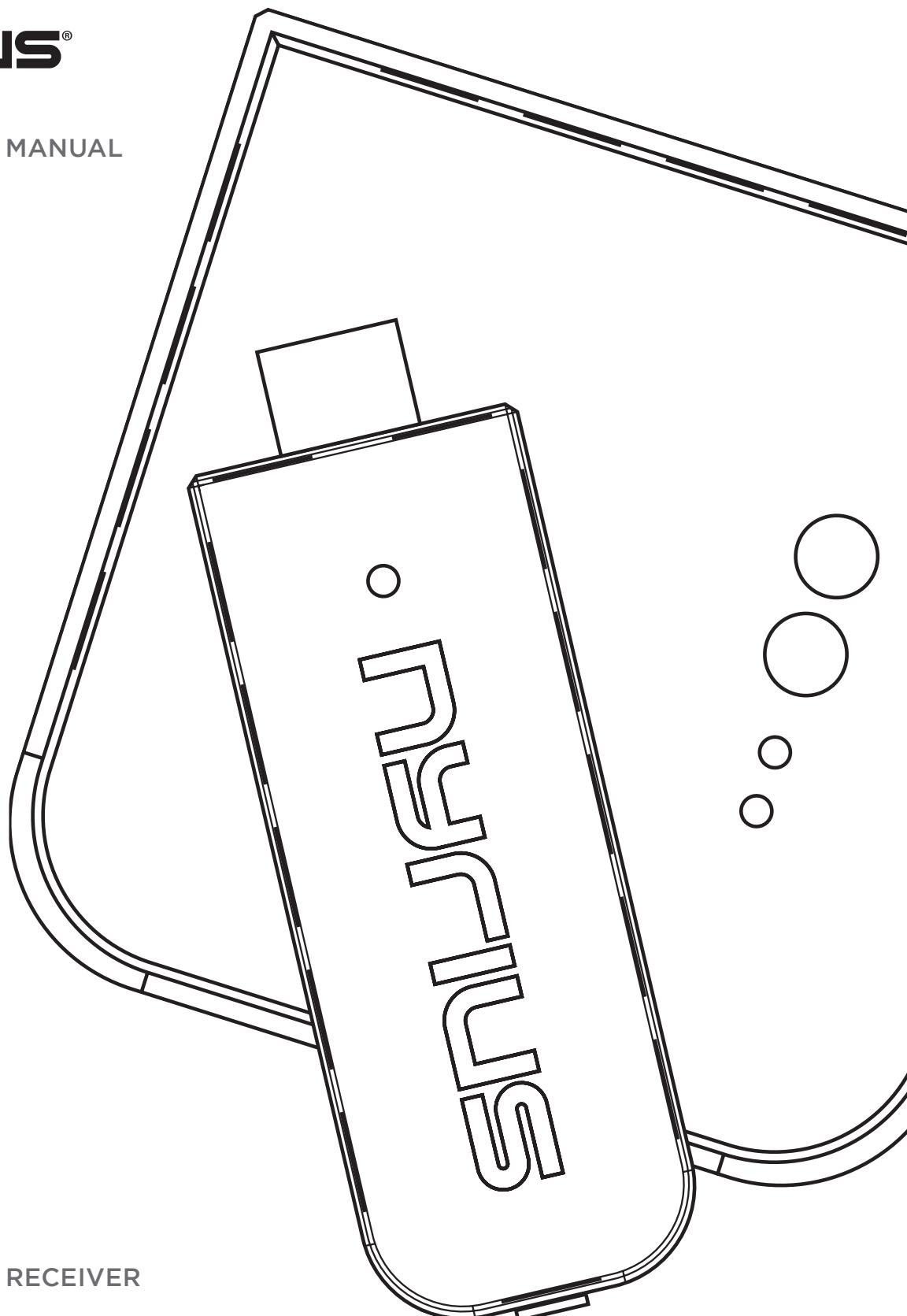

WIRELESS HD RECEIVER

CONTENT

WHAT'S INCLUDED.....3

PRODUCT OVERVIEW TRANSMITTER3

PRODUCT OVERVIEW RECEIVER.....4

TRANSMITTER INSTALLATION5

RECEIVER INSTALLATION.....6

LED BEHAVIOR7

STANDBY MODE8

INFO BUTTON.....8

COMPUTER DISPLAY OPTIONS.....8

PAIRING INSTRUCTIONS.....9

WALL MOUNTING.....10

DRILLING TEMPLATE10

TROUBLESHOOTING11

SPECIFICATIONS13

FCC STATEMENT14

IC STATEMENT15

SAFETY INFORMATION16

WARRANTY.....17

WHAT'S INCLUDED

Digital Wireless HD Transmitter
Digital Wireless HD Receiver
1 x 100-240V AC Power Adapter to Mini USB
Right Angle HDMI Adapter
2 x Screws/Screw Anchors

USB Power Cable
Instruction Manual
Quick Start Guide
1 Year Warranty
Lifetime Customer Support

PRODUCT OVERVIEW

TRANSMITTER

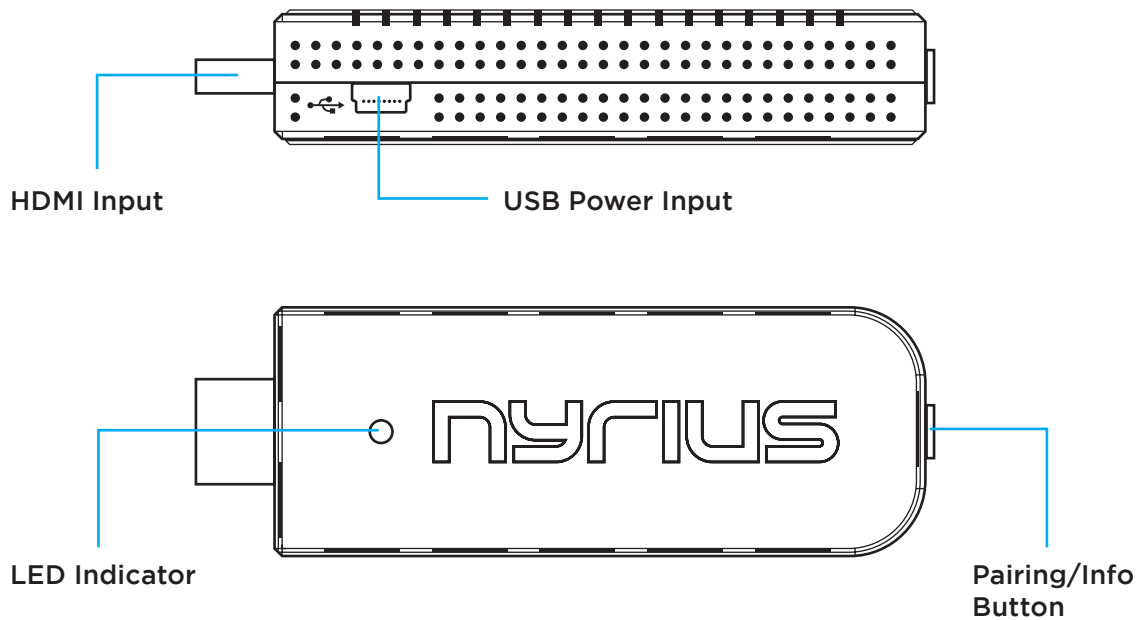

PRODUCT OVERVIEW

RECEIVER

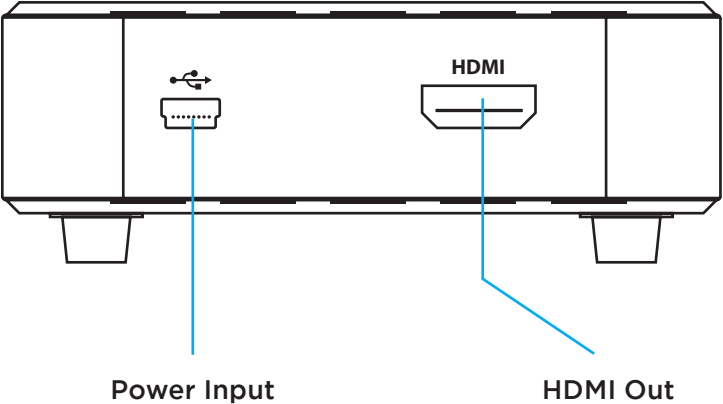
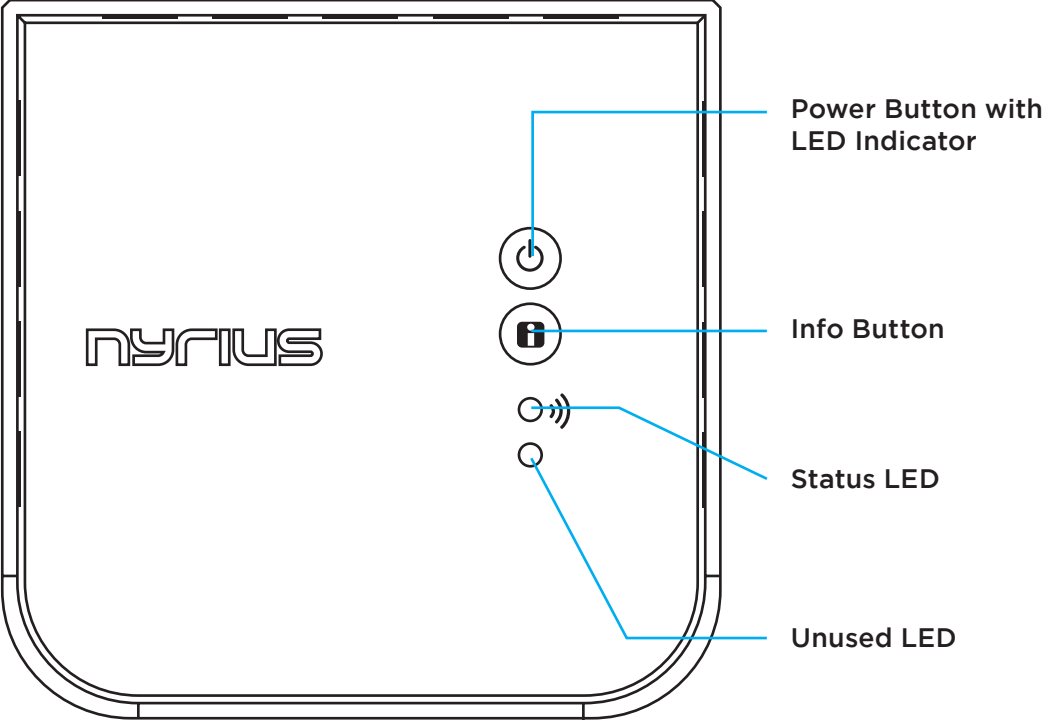

TRANSMITTER INSTALLATION

- Connect the Transmitter directly to the HDMI output on a PC, cable box or any HDMI device.
- Connect the Transmitter to power using the USB cable provided or connect the power adapter to the mini USB port on the Transmitter and plug it in to an available wall outlet.

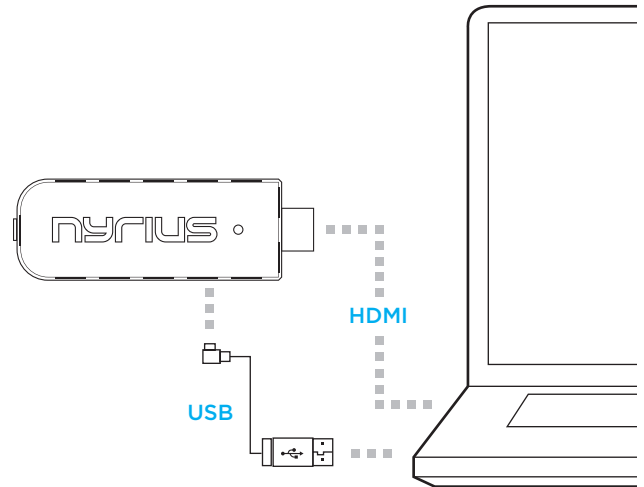

- You may also connect the Right Angle HDMI Adapter for easier setup with certain computers.

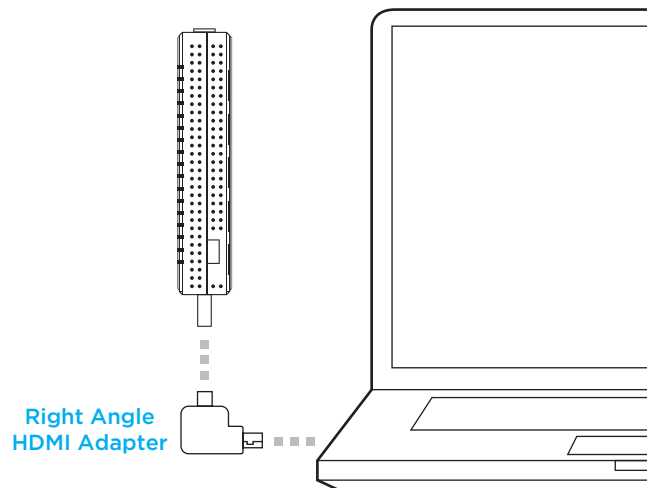

Note: The LED Indicator on the Transmitter will light up WHITE when the Transmitter is properly connected to the computer via USB.

RECEIVER INSTALLATION

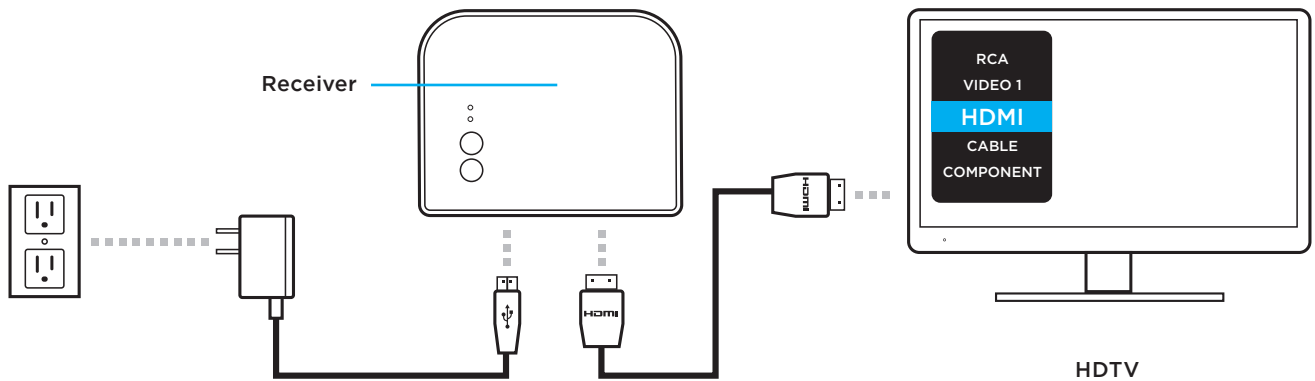

- Connect the HDMI cable to the HDMI Output of the Receiver and to your HDTV television or HD projector.
- Ensure your TV or projector is powered ON and is in "HDMI input" mode.
- Connect the power adapter to the DC Input of the Receiver and plug into a wall outlet. When the unit is successfully connected, the Power LED indicator on the POWER button lights up in WHITE.
- Once the Transmitter and Receiver are both connected, they will automatically pair to each other.
- When you disconnect the Transmitter and the link is disconnected over 10 minutes, the Receiver will enter STANDBY MODE (Power LED of the Receiver is Orange)
- When the Transmitter is reconnected the Receiver will automatically wake and reconnect. During the warm-up period, the POWER LED will flash WHITE until the signal between the Transmitter and the Receiver is established. It will take approximately 15 ~ 20 seconds to boot-up and establish a link providing everything is operating normally.
- If all is operating normally, the LEDs will be SOLID WHITE and setup will be complete.

Note: Obstacles may decrease transmission distance. Interference may come from other wireless devices using 5GHz band.

For maximum performance, please use the included power adapters.

LED BEHAVIOR

FUNCTION	STATUS	BEHAVIOR
SOLID WHITE	CONNECTED	Transmitter/Receiver is connected.
FLASHING WHITE	CONNECTING	Transmitter/Receiver are searching for connection.
SOLID ORANGE	STANDBY	Receiver is in standby mode.
SLOWLY FLASHING ORANGE	PAIRING	Receiver is in pairing mode

- If the system is unable to establish a connection within 80 seconds, the connection has been lost or the Transmitter is out of range. Verify the distance between the Transmitter and Receiver. The maximum video transmission range for 1080p content is up to 165ft in line of sight (LOS). The minimum range is 6.5ft.
- If no video is displayed and OSD (on-screen display) message states "NOT SUPPORTED FORMAT", then the video resolution from the computer is NOT supported.
- If you have more than one pair of each Transmitter/Receiver, each pair should be at least 6.5 feet away from each other.

STANDBY MODE

Press the **POWER** button on top of the Receiver to go from “Active mode” to “Active Standby mode”. When the transmitter is connected to power the Receiver will wake and reconnect.

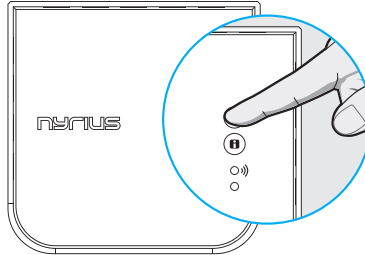

INFO BUTTON

Press the **INFO** button on the Receiver or Transmitter. The Signal Quality, Source, Channel and Resolution will be displayed on the OSD for your reference. Press the **INFO** button again to exit.

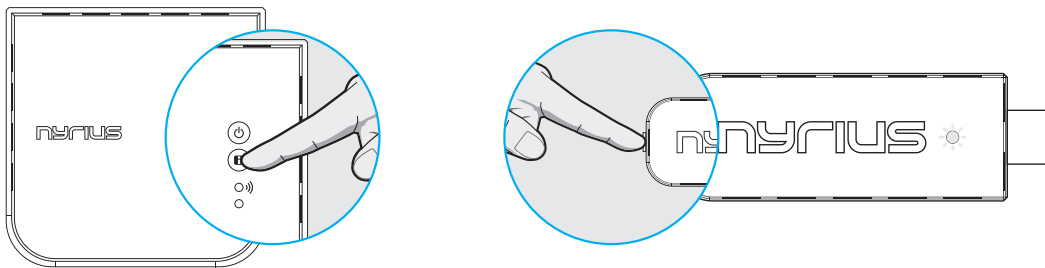

COMPUTER DISPLAY OPTIONS

You can change the display option in the computer’s display settings. Normal display options are “Extend”, “Duplicate”, or “Show desktop only on ...”. While all display options are supported by the NPC5650 some computers do not support all. Please check your computer manual for details on display options.

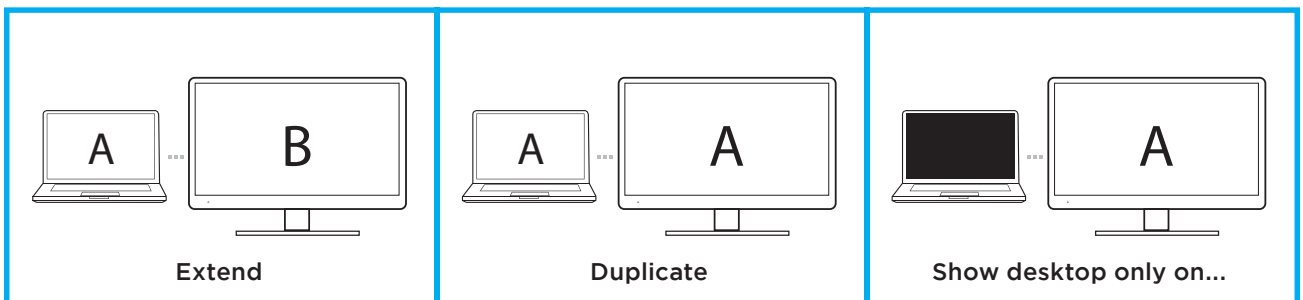

PAIRING INSTRUCTIONS

The NPC5650 Transmitter and Receiver come paired. If re-pairing is necessary use the below steps to reconnect the units.

- Press and hold down the power button LED on the Receiver and plug in the power adapter. Release the Power button once the power LED blinks orange.

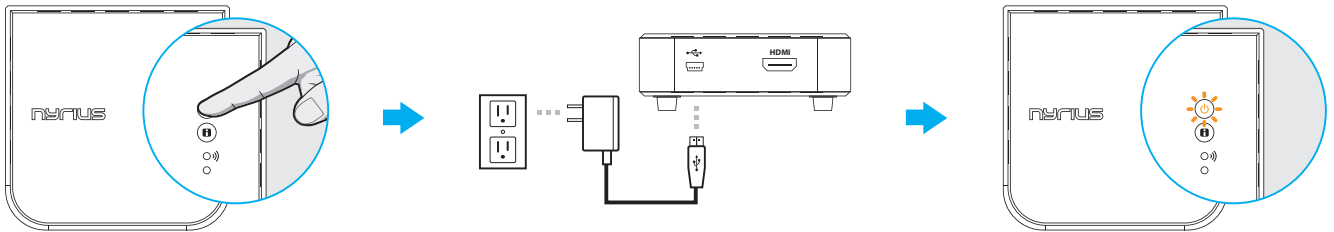

- Plug the power adapter into the Transmitter. Press and hold down the pairing button.

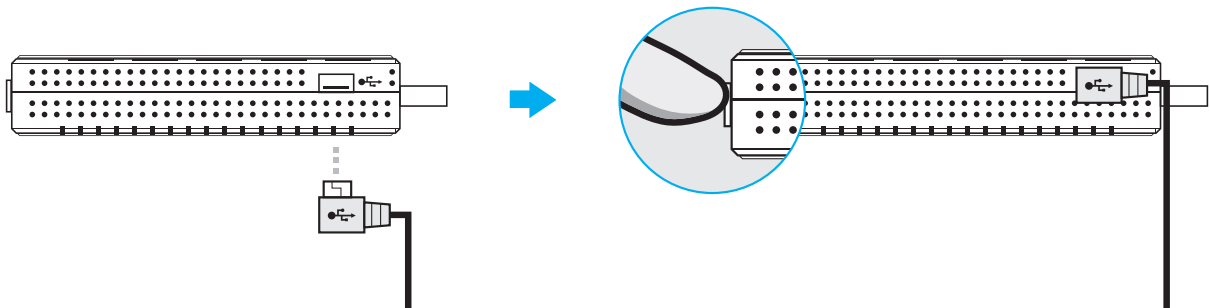

- The Power LED should be flashing white. The white flashing speed will begin to slow down. Once it has slowed down, release pairing button to enter pairing mode.

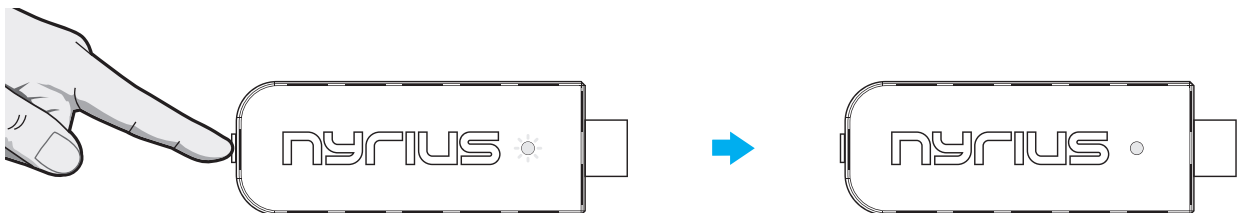

Note: The Transmitter and Receiver should complete pairing and once LEDs change to solid white connection will be complete.

WALL MOUNTING

1. Drill pilot holes using drilling template included below.
2. Insert the supplied two anchors into the wall.
3. Insert two screws into the anchors. Leave 1/8" length for mounting the Transmitter or Receiver.
4. Remove the rubber feet from the NPCS650. Place NPCS650 main holes over the protruding screws and slide down into position.

DRILLING TEMPLATE

Note: This template is to scale. When printing out please ensure your printer setting is set to Actual size (100%)

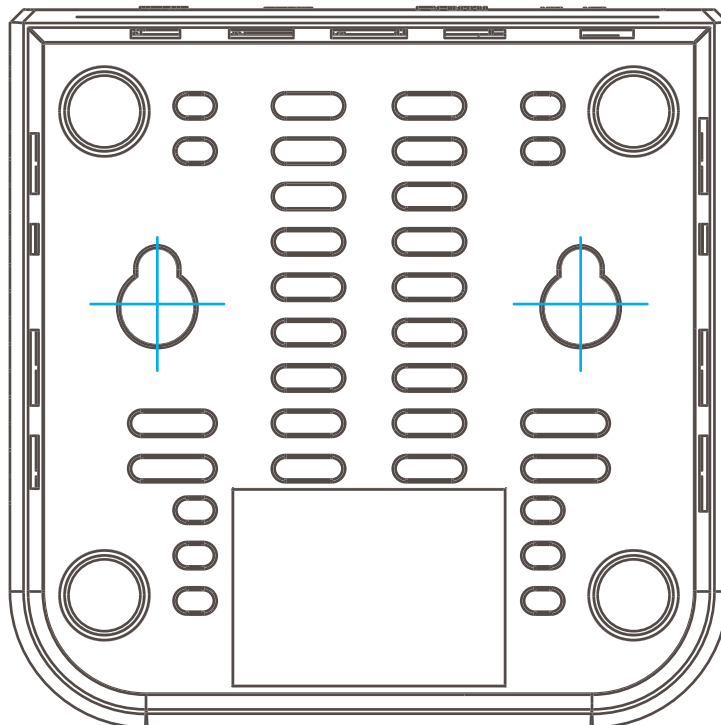

TROUBLESHOOTING

PROBLEM	SOLUTION
<p>POWER LED is not lighting up</p>	<p>Make sure the power is connected to the Receiver/Transmitter.</p> <p>Check that the power supplies are connected to a working power outlet. Some TV/Camera USB ports may not power TX/Receiver.</p> <p>The POWER LED of the Receiver should be WHITE and the LED Indicator of the Transmitter should be WHITE.</p>
<p>No Video is displayed</p>	<p>Check the status of the Link LEDs, and check TV or projector are working normally.</p> <p>Check the HDMI cable is undamaged and is plugged into the correct connection.</p> <p>Check that the correct HDMI output has been selected from the TV or projector's menu and that the HDMI cable is plugged into the correct output connection.</p> <p>Make sure that it is the Receiver that is connected to the TV or projector, and the Transmitter that is connected to a PC, cable box or any HDMI device.</p> <p>Verify the Receiver's POWER LED and STATUS LED indicators (see chart on page 7).</p> <p>Ensure your video resolution and frame rate is recognized/supported and within the transmission range.</p> <p>Connect the source device to your TV to check and modify the video format compatibility.</p> <p>Check your video resolution with HDMI input from your device is 1080p, 1080i, 720p, 576p, 480p.</p> <p>Ensure the display setting for your PC / Laptop has been switched to Extend Mode, Duplicate Mode or Show Desktop only on Mode to enable external display.</p>
<p>Bad Picture</p>	<p>Make sure the HDMI cables used are undamaged and that you can get a working connection when the source is connected directly to the display with an HDMI cable.</p> <p>Check that your video resolution with HDMI input from your PC / Laptop is either 1080p, 1080i, 720p, 576p, or 480p.</p> <p>Ensure the transmission distance is less than 165 feet (LOS).</p>

Bad Audio/ No Audio	<p>Make sure that the source is outputting supported audio formats.</p> <p>Make sure that the TV's volume is turned UP and not on MUTE.</p> <p>Make sure that your PC / Laptop audio volume has been turned UP.</p> <p>Make sure that your PC / Laptop audio output has been switched to HDMI out.</p> <p>Make sure there is no 5.8GHz wireless phone within 50cm of the Receiver. Some phones use substandard transmission schemes.</p>
Other	<p>If any other issue occurs or if the above issues persist, try disconnecting both Transmitter and Receiver and repeating the pairing process.</p>

**For further questions or inquires, please contact NYRIUS customer support at:
www.nyrius.com/contact**

SPECIFICATIONS

Wireless Technology	GigaXtreme Technology
System Requirements	Any laptop or desktop system containing an HDMI port including popular models from these manufacturers: Alienware, Asus, Lenovo, Dell, HP, Acer, Apple (display port cable not included)
Ports and Interfaces	HDMI, Mini-USB
Environmental Requirements	Operating temperature: 0° to 40° C, Storage temperature -10 ~ +55° C, Relative humidity: 15 ~ 80% RH
Power	5V DC and USB
Video Formats	TV: 1080p, 1080i, 720p, 576p, 480p PC : 1024x768, 1280x1024, 640x480, 800x600
Audio Formats Supported	Uncompressed 7.1 PCM , DTS , Dolby Digital Surround Sound
TV Compatibility	Any high-definition television including 3D TVs containing an HDMI port, including popular models from these manufacturers: Hitachi, JVC, LG, Mitsubishi, NEC, Panasonic, Philips, Pioneer, Samsung, Sony, Sharp, Toshiba, Vizio, Westinghouse
Wireless Range	165 ft (streaming line of sight results in maximum range)
Transmission Frequency	Transmission Frequency 4.9~ 5.9GHz with Dynamic Frequency Selecting (DFS)
Frequency Stability	AFS (Automatic Frequency Selection)
Bandwidth	40Mhz
Standard Protocol	HDMI 1.3, HDCP 1.2
System Latency	≤1 ms
TX/RX Channel	1 RX / 1 TX
Transmitter Dimensions	3.4 x 1.3 inches
Receiver Dimensions	3.7 x 3.8 x 1.1 inches
Adapter Compatibility	Nyrius does not recommend using Digital to Analog Adapters with our ARIES Products, however HDMI to miniHDMI/microHDMI adapters are compatible

FCC STATEMENT

This device complies with Part 15 of the FCC Rules. Operation is subject to the following two conditions: (1) This device may not cause harmful interference, and (2) this device must accept any interference received, including interference that may cause undesired operation.

WARNING:

This equipment has been tested and found to comply with the limits for a Class B digital device, pursuant to Part 15 of the FCC Rules. These limits are designed to provide reasonable protection against harmful interference in a residential installation. This equipment generates, uses and can radiate radio frequency energy and, if not installed and used in accordance with the instructions, may cause harmful interference to radio communications. However, there is no guarantee that interference will not occur in a particular installation. If this equipment does cause harmful interference to radio or television reception, which can be determined by turning the equipment off and on, the user is encouraged to try to correct the interference by one of the following measures:

- Reorient or relocate the receiving antenna.
- Increase the separation between the equipment and receiver.
- Connect the equipment into an outlet on a circuit different from that to which the receiver is connected.
- Consult the dealer or an experienced radio/TV technician for help.

FCC CAUTION:

Any changes or modifications not expressly approved by the party responsible for compliance could void the user's authority to operate this equipment.

This transmitter must not be co-located or operating in conjunction with any other antenna or transmitter.

TRANSMITTER

Operations in the 5.15-5.25 GHz band are restricted to indoor usage only.

RADIATION EXPOSURE STATEMENT (TRANSMITTER):

The product comply with the FCC portable RF exposure limit set forth for an uncontrolled environment and are safe for intended operation as described in this manual. The further RF exposure reduction can be achieved if the product can be kept as far as possible from the user body or set the device to lower output power if such function is available.

The USB dongle transmitter is approved for use in typical laptop computers. To comply with FCC RF exposure requirements, it should not be used in other devices or certain laptop and tablet computer configurations where the USB connectors on the host computer are unable to provide or ensure the necessary operating configurations intended

for the device and its users or bystanders to satisfy RF exposure compliance requirements. Receiver should be installed and operated with minimum distance 20cm between the radiator & your body

RECEIVER

For operation within 5.15-5.25 GHz / 5.47-5.725 GHz frequency range, it is restricted to indoor environment. The band from 5600-5650 MHz will be disabled by the software during the manufacturing and cannot be changed by the end user. This device meets all the other requirements specified in Part 15E, Section 15.407 of the FCC Rules.

RADIATION EXPOSURE STATEMENT (RECEIVER):

This equipment complies with FCC radiation exposure limits set forth for an uncontrolled environment. This equipment should be installed and operated with minimum distance 20cm between the radiator & your body.

Note: The country code selection is for non-US model only and is not available to all US model. Per FCC regulation, all WiFi product marketed in US must fixed to US operation channels only

IC STATEMENT

Industry Canada Statement

This device complies with ISED's licence-exempt RSSs. Operation is subject to the following two conditions: (1) This device may not cause harmful interference, and (2) this device must accept any interference received, including interference that may cause undesired operation

CAUTION :

(i) the device for operation in the band 5150-5250 MHz is only for indoor use to reduce the potential for harmful interference to co-channel mobile satellite systems; (ii) the maximum antenna gain permitted for devices in the bands 5250-5350 MHz and 5470-5725 MHz shall be such that the equipment still complies with the e.i.r.p. limit; (iii) the maximum antenna gain permitted for devices in the band 5725-5850 MHz shall be such that the equipment still complies with the e.i.r.p. limits specified for point-to-point and non-point-to-point operation as appropriate; and (iv) Users should also be advised that high-power radars are allocated as primary users (i.e. priority users) of the bands 5250-5350 MHz and 5650-5850 MHz and that these radars could cause interference and/or damage to LE-LAN devices.

RADIATION EXPOSURE STATEMENT:

This equipment complies with ISED radiation exposure limits set forth for an uncontrolled environment. This equipment should be installed and operated with minimum distance 20cm between the radiator & your body.

SAFETY INFORMATION

Read all instructions.

Keep these instructions.

Heed all warnings.

Follow all instructions.

Do not use this apparatus near water.

Clean only with a dry cloth.

Do not block any ventilation openings. Install in accordance with the manufacturer's instructions.

Do not install near any heat sources such as radiators, heat registers, stoves, or other apparatus (including amplifiers) that produce heat.

Do not defeat the safety purpose of the polarized or grounding-type plug. A polarized plug has two blades with one wider than the other. A grounding type plug has two blades and a third grounding prong. The wide blade or the third prong are provided for your safety. If the provided plug does not fit into your outlet, consult an electrician for replacement of the obsolete outlet.

Protect the power cord from being walked on or pinched particularly at plugs, convenience receptacles, and the point where they exit from the apparatus.

Only use attachments/accessories specified by the manufacturer.

Unplug this apparatus during lightning storms or when unused for long periods of time.

Refer all servicing to qualified service personnel. Servicing is required when the apparatus has been damaged in any way, such as power-supply cord or plug is damaged. Liquid has been spilled or objects have fallen into the apparatus, the apparatus has been exposed to rain or moisture, does not operate normally, or has been dropped.

Apparatus shall not be exposed to dripping or splashing, and that no objects filled with liquids, such as vases, shall be placed on the apparatus.

The battery shall not be exposed to excessive heat such as sunshine, fire or the like.

The direct plug-in adapter is used as disconnect device, the disconnect device shall remain readily operable.

WARNING: The battery is recyclable. Batteries shall not be exposed to heat such areas.

WARNING: To reduce the risk of fire or electric shock, do not expose this apparatus to rain or moisture.



This marking indicates that this product should not be disposed with other household wastes throughout North America. To prevent possible harm to the environment or human health from uncontrolled waste disposal, recycle it responsibly to promote the sustainable reuse of material resources. To return your used device, please use the return and collection systems or contact the retailer where the product was purchased. They can take this product for environmental safe recycling.

WARRANTY

Thank you for choosing Nyrius! We guarantee your investment in our products is a solid one. Our products come with a complete one-year parts and labor warranty. High performance components combined with quality craftsmanship allow us to maintain the highest possible production standards. All items are guaranteed against defects in materials and craftsmanship. Nyrius has outstanding quality control; if something should go wrong with any of our products, we will repair it free of charge within the warranty period. If the product cannot be repaired, we will replace the product. In the event that Nyrius replaces a product under warranty, the replacement would only carry the original warranty from the original date of purchase.

Warranty Exclusions:

Nyrius products are warranted for parts and labor for one year from date of original purchase, and are subject to the terms and conditions of the warranty. Any refurbished products that are discontinued hold a 90 day warranty from the date of original purchase. Nyrius warranties are valid for the original owner and are non-transferable.

- Any defects caused or repairs required as a result of abusive operation, negligence, accident, improper installation or inappropriate use as outlined in the owner's manual.
- Any product tampered with, modified, adjusted, or repaired by any party other than Nyrius.
- Damage caused or repairs required as a result of the use with items not specified or approved by Nyrius, including but not limited to chemical cleaning agents.
- Any cosmetic damage to the surface or exterior that has been defaced or caused by normal wear and tear.
- Any damage caused by external or environmental conditions, including but not limited to transmission line/power line voltage, or liquid spillage.
- Any product received without an appropriate model and serial number.
- Any products used for rental or commercial purposes.
- Any installation, set up and/or programming charges.

To Obtain Warranty Service

Should your product require warranty service, please contact us at www.nyrius.com/contact or call us at 1-888-738-4237 to set up a Return Authorization. Products returned without a valid Return Authorization number will be refused.

Nyrius products must be returned in their original packaging. Our products are packaged specially to protect them from any damage during shipping, and without this packaging the return shipment could get damaged.

This warranty does not cover the shipping cost, insurance, or any other incidental charges. Products shipped for warranty service must be pre-paid by the customer, and Nyrius will cover the cost to ship the repaired or replaced product back to the customer.